

pratic



Technical Catalogue

Fundamentals

BESCHREIBUNG DESCRIPTION

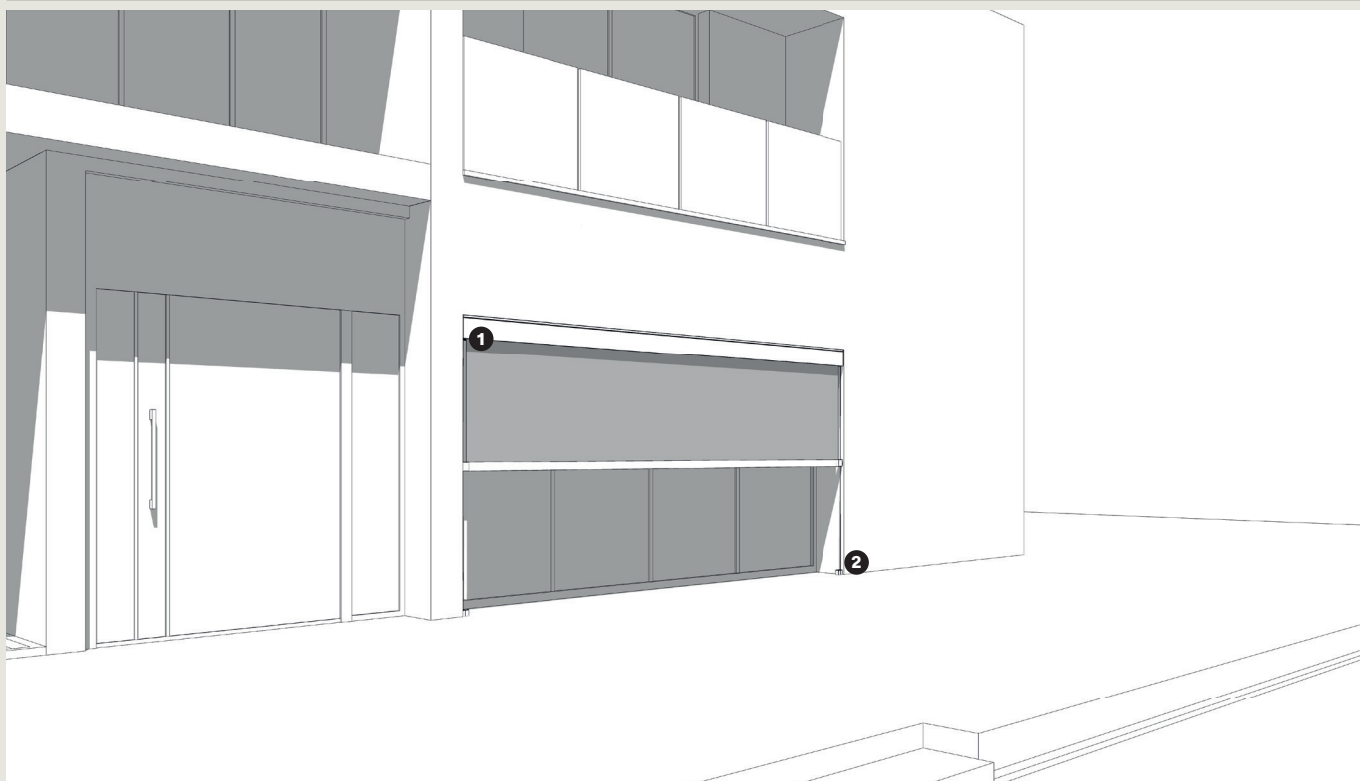

1. LED Line 2. Magnetic Lock System (MLS)
1. LED Line 2. Magnetic Lock System (MLS)

TECHNISCHE EIGENSCHAFTEN

- Senkrechtmarkise mit verschiebbarem Tuch
- Manuelle oder motorisierte Bedienung

WICHTIGE ANWEISUNGEN

- **Die im Benutzer- und Garantiehandbuch beschriebene Wartung wird empfohlen**
- **Es ist empfohlen, Messungen für senkrechten Markisen nach der Installation der Pergola durchzuführen**
- Die Abmessungen L und H sind als Fertigmaße der Markise zu betrachten und haben eine Toleranz von 0/-0,5 cm. Die Führungsschienen der senkrechten Markisen haben im Vergleich zum Nennmaß eine Reduzierung von 0,4 cm, um die Installation zu erleichtern
- Die Windwiderstandsklasse ist in der Tabelle der Beaufort-Skala verfügbar

CARACTÉRISTIQUES TECHNIQUES

- Store vertical avec toile coulissante
- Actionnement manuel ou motorisé

INDICATIONS IMPORTANTES

- **Les entretiens indiqués dans le manuel d'utilisation et de garantie sont recommandés**
- **Il est conseillé de prendre les mesures pour les stores verticaux après l'installation de la pergola**
- Les dimensions L et H sont à considérer comme des mesures finies du store et ont une tolérance de 0/-0,5 cm. Les rails verticaux des stores auront une réduction de 0,4 cm par rapport à la taille nominale pour faciliter l'installation
- La classe de résistance au vent est disponible dans le tableau de l'échelle Beaufort

Technische Details

Détails techniques

MAGNETIC LOCK SYSTEM (MLS) MAGNETIC LOCK SYSTEM (MLS)

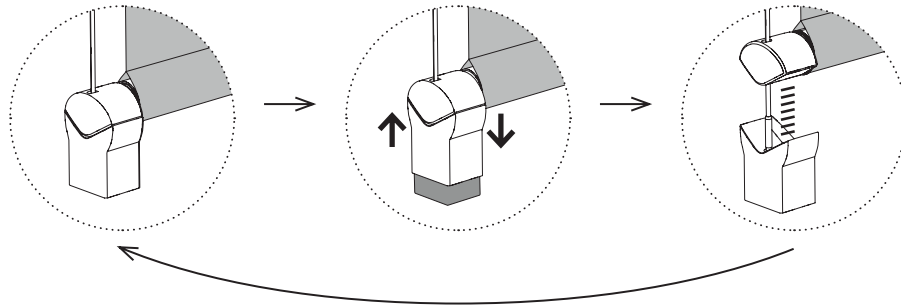

Bei Brisen dämpft das Magnetic Lock System (MLS) die Bewegungen des Ausfallprofils. Bei stärkeren Windböen hackt sich das System aus, so dass der Winddruck aufgelöst werden kann
En cas de brise, le Magnetic Lock System (MLS) amortit les mouvements de la barre de charge. En cas de rafales plus fortes, le système se désengage, pour permettre à la pression du vent de se dissiper.

Maßangaben

Détails des dimensions

RASO, MAXIMALE HERSTELLBARE HÖHE RASO, HAUTEUR MAXIMALE RÉALISABLE

Gewebe <i>Tissus</i>	H Stoffballen (cm) <i>H nappe (cm)</i>	Anfertigung des Gewebes <i>Réalisation tissu</i>	L Markise (cm) <i>L store (cm)</i>	H Markise (cm) <i>H store (cm)</i>
Acrylics, Polyester <i>Acrylics, Polyester</i>	120	↑	L ≤ 600	300
Cristal <i>Cristal</i>	140	→	L ≤ 450	300
Mosquito <i>Mosquito</i>	305	→	L ≤ 450	300
Lunar Screen 989 <i>Lunar Screen 989</i>	210	→	L ≤ 600	300
	210	↑	L ≤ 215	300
PVC 302 - PVC 502 <i>PVC 302 - PVC 502</i>	180	→	L ≤ 600	300
	180	↑	L ≤ 185	300
PVC 622 <i>PVC 622</i>	267	→	L ≤ 600	300
	267	↑	L ≤ 272	300
Opatex <i>Opatex</i>	300	→	L ≤ 600	300
	300	↑	L ≤ 305	300
Screen SG989 <i>Screen SG989</i>	270	→	L ≤ 600	300
	270	↑	L ≤ 275	300
	320	→	L ≤ 600	300
	320	↑	L ≤ 325	300
Soltis 86H, Soltis 92P <i>Soltis 86H, Soltis 92P</i>	177	→	L ≤ 600	300
	177	↑	L ≤ 182	300
	267	→	L ≤ 600	300
	267	↑	L ≤ 272	300
Soltis Opaque 92B <i>Soltis Opaque 92B</i>	170	→	L ≤ 600	300
	170	↑	L ≤ 175	300
Soltis W88 - Soltis W96 <i>Soltis W88 - Soltis W96</i>	267	→	L ≤ 600	300
	267	↑	L ≤ 272	300
Veozip <i>Veozip</i>	290	→	L ≤ 600	300
	290	↑	L ≤ 295	300

Maßangaben

Détails des dimensions

T-LOOP S90, MAXIMALE HERSTELLBARE HÖHE
T-LOOP S90, HAUTEUR MAXIMALE RÉALISABLE

Gewebe <i>Tissus</i>	H Stoffballen (cm) <i>H nappe (cm)</i>	Anfertigung des Gewebes <i>Réalisation tissu</i>	L Markise (cm) <i>L store (cm)</i>	H Markise (cm) <i>H store (cm)</i>
Acrylics, Polyester <i>Acrylics, Polyester</i>	120	↑	$L \leq 300$	200
Mosquito <i>Mosquito</i>	305	→	$L \leq 300$	300
	305	↑	$L \leq 300$	300
Lunar Screen 989 <i>Lunar Screen 989</i>	210	→	$L \leq 300$	300
	210	↑	$L \leq 214$	300
PVC 302 - PVC 502 <i>PVC 302 - PVC 502</i>	180	→	$L \leq 300$	300
	180	↑	$L \leq 184$	300
PVC 622 <i>PVC 622</i>	267	→	$L \leq 300$	300
	267	↑	$L \leq 271$	300
Opatex <i>Opatex</i>	300	→	$L \leq 300$	300
	300	↑	$L \leq 304$	300
Screen SG989 <i>Screen SG989</i>	270	→	$L \leq 300$	300
	270	↑	$L \leq 271$	300
	320	→	$L \leq 300$	300
	320	↑	$271 < L \leq 300$	300
Soltis 86H, Soltis 92P <i>Soltis 86H, Soltis 92P</i>	177	→	$L \leq 300$	300
	177	↑	$L \leq 181$	300
	267	→	$L \leq 300$	300
	267	↑	$181 < L \leq 271$	300
Soltis Opaque 92B <i>Soltis Opaque 92B</i>	170	→	$L \leq 300$	300
	170	↑	$L \leq 174$	300
Soltis W88 - Soltis W96 <i>Soltis W88 - Soltis W96</i>	267	→	$L \leq 300$	300
	267	↑	$L \leq 271$	300
Veozip <i>Veozip</i>	290	→	$L \leq 300$	275
	290	↑	$L \leq 294$	275

Maßangaben

Détails des dimensions

T-LOOP S98, MAXIMALE HERSTELLBARE HÖHE T-LOOP S98, HAUTEUR MAXIMALE RÉALISABLE

Gewebe Tissus	H Stoffballen (cm) H nappe (cm)	Anfertigung des Gewebes Réalisation tissu	L Markise (cm) L store (cm)	H Markise (cm) H store (cm)
Acrylics, Polyester <i>Acrylics, Polyester</i>	120	↑	L ≤ 400	200
Mosquito <i>Mosquito</i>	305	→	L ≤ 400	300
	305	↑	L ≤ 309	300
Lunar Screen 989 <i>Lunar Screen 989</i>	210	→	L ≤ 400	300
	210	↑	L ≤ 214	300
PVC 302 - PVC 502 <i>PVC 302 - PVC 502</i>	180	→	L ≤ 400	300
	180	↑	L ≤ 184	300
PVC 622 <i>PVC 622</i>	267	→	L ≤ 400	300
	267	↑	L ≤ 271	300
Opatex <i>Opatex</i>	300	→	L ≤ 400	300
	300	↑	L ≤ 304	300
Screen SG989 <i>Screen SG989</i>	270	→	L ≤ 400	300
	270	↑	L ≤ 271	300
	320	→	L ≤ 400	300
	320	↑	271 < L ≤ 324	300
Soltis 86H, Soltis 92P <i>Soltis 86H, Soltis 92P</i>	177	→	L ≤ 400	300
	177	↑	L ≤ 181	300
	267	→	L ≤ 400	300
	267	↑	181 < L ≤ 271	300
Soltis Opaque 92B <i>Soltis Opaque 92B</i>	170	→	L ≤ 400	300
	170	↑	L ≤ 174	300
Soltis W88 - Soltis W96 <i>Soltis W88 - Soltis W96</i>	267	→	L ≤ 400	300
	267	↑	L ≤ 271	300
Veozip <i>Veozip</i>	290	→	L ≤ 400	275
	290	↑	L ≤ 294	275

Maßangaben

Détails des dimensions

T-LOOP S114, MAXIMALE HERSTELLBARE HÖHE T-LOOP S114, HAUTEUR MAXIMALE RÉALISABLE

Gewebe Tissus	H Stoffballen (cm) H nappe (cm)	Anfertigung des Gewebes Réalisation tissu	L Markise (cm) L store (cm)	H Markise (cm) H store (cm)
Acrylics, Polyester <i>Acrylics, Polyester</i>	120	↑	L ≤ 500	300
Mosquito <i>Mosquito</i>	305	→	L ≤ 450	300
	305	↑	L ≤ 309	300
Lunar Screen 989 <i>Lunar Screen 989</i>	210	→	L ≤ 425	350
	210	→	425 < L ≤ 450	325
	210	→	450 < L ≤ 500	300
	210	↑	L ≤ 214	350
	180	→	L ≤ 425	350
PVC 302 - PVC 502 <i>PVC 302 - PVC 502</i>	180	→	425 < L ≤ 450	328
	180	→	450 < L ≤ 500	300
	180	↑	L ≤ 184	350
PVC 622 <i>PVC 622</i>	267	→	L ≤ 425	350
	267	→	425 < L ≤ 450	325
	267	→	450 < L ≤ 500	300
	267	↑	L ≤ 271	350
Opatex <i>Opatex</i>	300	→	L ≤ 425	350
	300	→	425 < L ≤ 450	325
	300	→	450 < L ≤ 500	300
	300	↑	L ≤ 304	350
Screen SG989 <i>Screen SG989</i>	270	→	L ≤ 425	350
	270	→	425 < L ≤ 450	325
	270	→	450 < L ≤ 500	300
	270	↑	L ≤ 271	350
	320	→	L ≤ 425	350
	320	→	425 < L ≤ 450	325
	320	→	450 < L ≤ 500	300
Soltis 86H, Soltis 92P <i>Soltis 86H, Soltis 92P</i>	320	↑	271 < L ≤ 324	350
	177	→	L ≤ 425	350
	177	→	425 < L ≤ 450	322
	177	→	450 < L ≤ 500	300
	177	↑	L ≤ 181	350
	267	→	L ≤ 425	350
	267	→	425 < L ≤ 450	325
	267	→	450 < L ≤ 500	300
Soltis Opaque 92B <i>Soltis Opaque 92B</i>	267	↑	181 < L ≤ 271	325
	170	→	L ≤ 425	350
	170	→	425 < L ≤ 450	325
	170	→	450 < L ≤ 500	300
Soltis W88 - Soltis W96 <i>Soltis W88 - Soltis W96</i>	170	↑	L ≤ 174	350
	267	→	L ≤ 425	350
	267	→	425 < L ≤ 450	325
	267	→	450 < L ≤ 500	300
Veozip <i>Veozip</i>	267	↑	L ≤ 271	350
	290	→	L ≤ 425	350
	290	→	425 < L ≤ 450	325
	290	-	450 < L ≤ 500	300
	290	↑	L ≤ 294	350

Maßangaben

Détails des dimensions

T-ZONE SC98 UND T-ZONE S98, MAXIMALE HERSTELLBARE HÖHE

T-ZONE SC98 ET T-ZONE S98, HAUTEUR MAXIMALE RÉALISABLE

Gewebe Tissus	H Stoffballen (cm) H nappe (cm)	Anfertigung des Gewebes Réalisation tissu	L Markise (cm) L store (cm)	H Markise (cm) H store (cm)
Acrylics, Polyester <i>Acrylics, Polyester</i>	120	↑	L ≤ 400	200
Cristal <i>Cristal</i>	140	→	L ≤ 400	300
	140	↑	L ≤ 132	300
Mosquito <i>Mosquito</i>	305	→	L ≤ 400	300
	305	↑	L ≤ 309	300
Lunar Screen 989 <i>Lunar Screen 989</i>	210	→	L ≤ 400	300
	210	↑	L ≤ 214	300
PVC 302 - PVC 502 <i>PVC 302 - PVC 502</i>	180	→	L ≤ 400	300
	180	↑	L ≤ 184	300
PVC 622 <i>PVC 622</i>	267	→	L ≤ 400	300
	267	↑	L ≤ 271	300
Opatex <i>Opatex</i>	300	→	L ≤ 400	300
	300	↑	L ≤ 304	300
Screen SG989 <i>Screen SG989</i>	270	→	L ≤ 400	300
	270	↑	L ≤ 271	300
	320	→	L ≤ 400	300
	320	↑	271 < L ≤ 324	300
Soltis 86H, Soltis 92P <i>Soltis 86H, Soltis 92P</i>	177	→	L ≤ 400	300
	177	↑	L ≤ 181	300
	267	→	L ≤ 400	300
	267	↑	181 < L ≤ 271	300
Soltis Opaque 92B <i>Soltis Opaque 92B</i>	170	→	L ≤ 400	300
	170	↑	L ≤ 174	300
Soltis W88 - Soltis W96 <i>Soltis W88 - Soltis W96</i>	267	→	L ≤ 400	300
	267	↑	L ≤ 271	300
Veozip <i>Veozip</i>	290	→	L ≤ 400	275
	290	↑	L ≤ 294	275

Maßangaben

Détails des dimensions

T-ZONE S114, MAXIMALE HERSTELLBARE HÖHE T-ZONE S114, HAUTEUR MAXIMALE RÉALISABLE

Gewebe Tissus	H Stoffballen (cm) H nappe (cm)	Anfertigung des Gewebes Réalisation tissu	L Markise (cm) L store (cm)	H Markise (cm) H store (cm)
Acrylics, Polyester <i>Acrylics, Polyester</i>	120	↑	L ≤ 500	300
Cristal <i>Cristal</i>	140	→	L ≤ 450	300
	140	↑	L ≤ 132	300
Mosquito <i>Mosquito</i>	305	→	L ≤ 450	300
	305	↑	L ≤ 309	300
Lunar Screen 989 <i>Lunar Screen 989</i>	210	→	L ≤ 425	350
	210	→	425 < L ≤ 450	325
	210	→	450 < L ≤ 500	300
	210	↑	L ≤ 214	350
PVC 302 - PVC 502 <i>PVC 302 - PVC 502</i>	180	→	L ≤ 425	350
	180	→	425 < L ≤ 450	328
	180	→	450 < L ≤ 500	300
	180	↑	L ≤ 184	350
PVC 622 <i>PVC 622</i>	267	→	L ≤ 425	350
	267	→	425 < L ≤ 450	325
	267	→	450 < L ≤ 500	300
	267	↑	L ≤ 271	350
Opatex <i>Opatex</i>	300	→	L ≤ 425	350
	300	→	425 < L ≤ 450	325
	300	→	450 < L ≤ 500	300
	300	↑	L ≤ 304	350
Screen SG989 <i>Screen SG989</i>	270	→	L ≤ 425	350
	270	→	425 < L ≤ 450	325
	270	→	450 < L ≤ 500	300
	270	↑	L ≤ 271	350
	320	→	L ≤ 425	350
	320	→	425 < L ≤ 450	325
	320	→	450 < L ≤ 500	300
	320	↑	271 < L ≤ 324	350
Soltis 86H, Soltis 92P <i>Soltis 86H, Soltis 92P</i>	177	→	L ≤ 425	350
	177	→	425 < L ≤ 450	322
	177	→	450 < L ≤ 500	300
	177	↑	L ≤ 181	350
	267	→	L ≤ 425	350
	267	→	425 < L ≤ 450	325
	267	→	450 < L ≤ 500	300
Soltis Opaque 92B <i>Soltis Opaque 92B</i>	170	→	L ≤ 425	350
	170	→	425 < L ≤ 450	325
	170	→	450 < L ≤ 500	300
	170	↑	L ≤ 174	350
Soltis W88 - Soltis W96 <i>Soltis W88 - Soltis W96</i>	267	→	L ≤ 425	350
	267	→	425 < L ≤ 450	325
	267	→	450 < L ≤ 500	300
Veozip <i>Veozip</i>	267	↑	L ≤ 271	350
	290	→	L ≤ 425	350
	290	→	425 < L ≤ 450	325
	290	-	450 < L ≤ 500	300
	290	↑	L ≤ 294	350

Maßangaben

Détails des dimensions

T-BOX CABLES, MAXIMALE HERSTELLBARE HÖHE T-BOX CABLES, HAUTEUR MAXIMALE RÉALISABLE

Gewebe Tissus	H Stoffballen (cm) H nappe (cm)	Anfertigung des Gewebes Réalisation tissu	L Markise (cm) L store (cm)	H Markise (cm) H store (cm)
Acrylics, Polyester <i>Acrylics, Polyester</i>	120	↑	L ≤ 450	275
Lunar Screen 989 <i>Lunar Screen 989</i>	210	→	L ≤ 350	425
	210	→	350 < L ≤ 375	400
	210	→	375 < L ≤ 400	350
	210	→	400 < L ≤ 450	325
	210	↑	L ≤ 217	425
PVC 302 - PVC502 <i>PVC 302 - PVC502</i>	180	→	L ≤ 325	450
	180	→	325 < L ≤ 425	350
	180	→	425 < L ≤ 450	328
	180	↑	L ≤ 187	450
PVC 622 <i>PVC 622</i>	267	→	L ≤ 325	450
	267	→	325 < L ≤ 425	350
	267	→	425 < L ≤ 450	328
	267	↑	L ≤ 274	450
Opatex <i>Opatex</i>	300	→	L ≤ 325	450
	300	→	325 < L ≤ 400	350
	300	↑	L ≤ 307	450
Screen SG989 <i>Screen SG989</i>	270	→	L ≤ 325	450
	270	→	325 < L ≤ 425	350
	270	→	425 < L ≤ 450	237
	270	↑	L ≤ 274	450
	320	→	L ≤ 325	450
	320	→	325 < L ≤ 425	350
	320	→	425 < L ≤ 450	290
	320	↑	274 < L ≤ 300	450
Soltis 86H, Soltis 92P <i>Soltis 86H, Soltis 92P</i>	320	↑	300 < L ≤ 327	350
	177	→	L ≤ 325	450
	177	→	325 < L ≤ 425	350
	177	→	425 < L ≤ 450	322
	177	↑	L ≤ 184	450
	267	→	L ≤ 325	450
	267	→	325 < L ≤ 425	350
	267	→	425 < L ≤ 450	237
Soltis Opaque 92B <i>Soltis Opaque 92B</i>	267	↑	184 < L ≤ 274	450
	170	→	L ≤ 325	450
	170	→	325 < L ≤ 425	350
	170	→	425 < L ≤ 450	325
Soltis W88 - Soltis W96 <i>Soltis W88 - Soltis W96</i>	170	↑	L ≤ 177	450
	267	→	L ≤ 325	450
	267	→	325 < L ≤ 425	350
	267	→	425 < L ≤ 450	237
Veozip <i>Veozip</i>	267	↑	L ≤ 274	450
	290	→	L ≤ 400	350
	290	→	400 < L ≤ 450	275
	290	↑	L ≤ 297	350

Maßangaben

Détails des dimensions

T-BOX ZIP, MAXIMALE HERSTELLBARE HÖHE T-BOX ZIP, HAUTEUR MAXIMALE RÉALISABLE

Gewebe Tissus	H Stoffballen (cm) H nappe (cm)	Anfertigung des Gewebes Réalisation tissu	L Markise (cm) L store (cm)	H Markise (cm) H store (cm)
Acrylics, Polyester <i>Acrylics, Polyester</i>	120	↑	L ≤ 400	275
	120	↑	400 < L ≤ 500	200
Cristal <i>Cristal</i>	140	↑ → -	L ≤ 450	300
	140	↑	L ≤ 132	300
Mosquito <i>Mosquito</i>	305	→	L ≤ 450	300
	305	↑	L ≤ 309	300
Lunar Screen 989 <i>Lunar Screen 989</i>	210	→	L ≤ 400	350
	210	→	400 < L ≤ 450	325
	210	→	450 < L ≤ 500	300
	210	↑	L ≤ 214	350
PVC 302 - PVC502 <i>PVC 302 - PVC502</i>	180	→	L ≤ 425	350
	180	→	425 < L ≤ 450	328
	180	→	450 < L ≤ 500	300
	180	↑	L ≤ 184	350
PVC 622 <i>PVC 622</i>	267	→	L ≤ 425	350
	267	→	425 < L ≤ 450	325
	267	→	450 < L ≤ 500	300
	267	↑	L ≤ 271	350
Opatex <i>Opatex</i>	300	→	L ≤ 425	350
	300	→	425 < L ≤ 450	325
	300	→	450 < L ≤ 500	300
	300	↑	L ≤ 304	350
Screen SG989 <i>Screen SG989</i>	270	→	L ≤ 425	350
	270	→	425 < L ≤ 450	325
	270	→	450 < L ≤ 500	300
	270	↑	L ≤ 271	350
	320	→	L ≤ 425	350
	320	→	425 < L ≤ 450	325
	320	→	450 < L ≤ 500	300
	320	↑	271 < L ≤ 324	350
Soltis 86H, Soltis 92P <i>Soltis 86H, Soltis 92P</i>	177	→	L ≤ 425	350
	177	→	425 < L ≤ 450	322
	177	→	450 < L ≤ 500	300
	177	↑	L ≤ 181	350
	267	→	L ≤ 425	350
	267	→	425 < L ≤ 450	325
	267	→	450 < L ≤ 500	300
Soltis Opaque 92B <i>Soltis Opaque 92B</i>	170	→	L ≤ 425	350
	170	→	425 < L ≤ 450	325
	170	→	450 < L ≤ 500	300
	170	↑	L ≤ 174	350
Soltis W88 - Soltis W96 <i>Soltis W88 - Soltis W96</i>	267	→	L ≤ 425	350
	267	→	425 < L ≤ 450	325
	267	→	450 < L ≤ 500	300
	267	↑	L ≤ 271	350
Veozip <i>Veozip</i>	290	→	L ≤ 400	350
	290	→	400 < L ≤ 500	275
	290	↑	L ≤ 294	350

Maßangaben

Détails des dimensions

T-LINE, MAXIMALE HERSTELLBARE HÖHE T-LINE, HAUTEUR MAXIMALE RÉALISABLE

Gewebe Tissus	H Stoffballen (cm) H nappe (cm)	Anfertigung des Gewebes Réalisation tissu	L Markise (cm) L store (cm)	H Markise (cm) H store (cm)
Acrylics, Polyester <i>Acrylics, Polyester</i>	120	↑	L ≤ 360	250
Lunar Screen 989 <i>Lunar Screen 989</i>	210	→	L ≤ 400	300
	210	↑	L ≤ 222	300
PVC 302 <i>PVC 302</i>	180	→	L ≤ 360	250
PVC 622 <i>PVC 622</i>	267	→	L ≤ 360	250
Screen SG989 <i>Screen SG989</i>	270 / 320	→	L ≤ 250	360
	270 / 320	-	250 < L ≤ 400	300
	270	↑	L ≤ 279	350
	320	↑	L ≤ 332	350
Soltis W96 <i>Soltis W96</i>	267	→	L ≤ 250	360
	267	-	250 < L ≤ 400	300
	267	↑	L ≤ 279	360
	267	↑	L ≤ 279	360
Soltis 86H, Soltis 92P <i>Soltis 86H, Soltis 92P</i>	177	→	L ≤ 400	305
	177	↑	L ≤ 189	450
	267	→	L ≤ 250	450
	267	-	250 < L ≤ 400	300
	267	↑	L ≤ 279	350
Soltis Opaque 92B <i>Soltis Opaque 92B</i>	170	→	L ≤ 250	360
	170	-	250 < L ≤ 400	300
	170	↑	L ≤ 182	360
Soltis W88 <i>Soltis W88</i>	267	→	L ≤ 250	360
	267	-	250 < L ≤ 400	300
	267	↑	L ≤ 279	360
Veozip <i>Veozip</i>	290	→	L ≤ 400	300
	290	↑	L ≤ 302	300

Maßangaben

Détails des dimensions

T-SQUARE, MAXIMALE HERSTELLBARE HÖHE
T-SQUARE, HAUTEUR MAXIMALE RÉALISABLE

Gewebe <i>Tissus</i>	H Stoffballen (cm) <i>H nappe (cm)</i>	Anfertigung des Gewebes <i>Réalisation tissu</i>	L Markise (cm) <i>L store (cm)</i>	H Markise (cm) <i>H store (cm)</i>
Acrylics, Polyester <i>Acrylics, Polyester</i>	120	↑	L ≤ 360	162
Lunar Screen 989 <i>Lunar Screen 989</i>	210	→	L ≤ 400	200
	210	↑	L ≤ 222	200
PVC 302 <i>PVC 302</i>	180	→	L ≤ 360	230
PVC 622 <i>PVC 622</i>	267	→	L ≤ 360	230
Screen SG989 <i>Screen SG989</i>	270 / 320	→	L ≤ 250	240
	270 / 320	-	250 < L ≤ 400	240
	270	↑	L ≤ 279	240
	320	↑	L ≤ 332	240
Soltis W96 <i>Soltis W96</i>	267	→	L ≤ 250	240
	267	-	250 < L ≤ 400	240
	267	↑	L ≤ 279	240
	267	↑	L ≤ 279	240
Soltis 86H, Soltis 92P <i>Soltis 86H, Soltis 92P</i>	177	→	L ≤ 400	305
	177	↑	L ≤ 189	340
	267	→	L ≤ 250	340
	267	-	250 < L ≤ 400	300
	267	↑	L ≤ 279	340
Soltis Opaque 92B <i>Soltis Opaque 92B</i>	170	→	L ≤ 250	240
	170	-	250 < L ≤ 400	240
	170	↑	L ≤ 182	240
Soltis W88 <i>Soltis W88</i>	267	→	L ≤ 250	340
	267	-	250 < L ≤ 400	300
	267	↑	L ≤ 279	340
Veozip <i>Veozip</i>	290	→	L ≤ 400	175
	290	↑	L ≤ 302	175

Maßangaben

Détails des dimensions

XX1, MAXIMALE HERSTELLBARE HÖHE XX1, HAUTEUR MAXIMALE RÉALISABLE

Gewebe Tissus	H Stoffballen (cm) H nappe (cm)	Anfertigung des Gewebes Réalisation tissu	L Markise (cm) L store (cm)	H Markise (cm) H store (cm)
Acrylics, Polyester <i>Acrylics, Polyester</i>	120	↑	L ≤ 550	350
Lunar Screen 989 <i>Lunar Screen 989</i>	210	→	L ≤ 550	350
		↑	L ≤ 220	350
PVC 302 - PVC 502 <i>PVC 302 - PVC 502</i>	180	→	L ≤ 550	350
		↑	L ≤ 190	350
PVC 622 <i>PVC 622</i>	267	→	L ≤ 550	350
		↑	L ≤ 277	350
Opatex <i>Opatex</i>	300	→	L ≤ 550	350
		↑	L ≤ 310	350
Screen SG989 <i>Screen SG989</i>	270	→	L ≤ 550	350
		↑	L ≤ 280	350
	320	→	L ≤ 550	350
		↑	L ≤ 330	350
Soltis 86H, Soltis 92P <i>Soltis 86H, Soltis 92P</i>	177	→	L ≤ 550	350
		↑	L ≤ 187	350
	267	→	L ≤ 550	350
		↑	L ≤ 277	350
Soltis Opaque B92 <i>Soltis Opaque B92</i>	170	→	L ≤ 550	350
		↑	L ≤ 180	350
Soltis W88 - Soltis W96 <i>Soltis W88 - Soltis W96</i>	267	→	L ≤ 550	350
		↑	L ≤ 277	350
Veozip <i>Veozip</i>	290	→	L ≤ 550	350
		↑	L ≤ 300	350

Maßangaben

Détails des dimensions

X3, MAXIMALE HERSTELLBARE HÖHE X3, HAUTEUR MAXIMALE RÉALISABLE

Gewebe <i>Tissus</i>	H Stoffballen (cm) <i>H nappe (cm)</i>	Anfertigung des Gewebes <i>Réalisation tissu</i>	L Markise (cm) <i>L store (cm)</i>	H Markise (cm) <i>H store (cm)</i>
Acrylics, Polyester <i>Acrylics, Polyester</i>	120	↑	L ≤ 400	300
Lunar Screen 989 <i>Lunar Screen 989</i>	210	→	L ≤ 400	300
	210	↑	L ≤ 220	300
PVC 302 - PVC502 <i>PVC 302 - PVC502</i>	180	→	L ≤ 400	300
	180	↑	L ≤ 190	300
PVC 622 <i>PVC 622</i>	267	→	L ≤ 400	300
	267	↑	L ≤ 277	300
Opatex <i>Opatex</i>	300	→	L ≤ 400	300
	300	↑	L ≤ 310	300
Screen SG989 <i>Screen SG989</i>	270	→	L ≤ 400	300
	270	↑	L ≤ 280	300
	320	→	L ≤ 400	300
	320	↑	L ≤ 330	300
Soltis 86H, Soltis 92P <i>Soltis 86H, Soltis 92P</i>	177	→	L ≤ 400	300
	177	↑	L ≤ 187	300
	267	→	L ≤ 400	300
	267	↑	L ≤ 277	300
Soltis Opaque B92 <i>Soltis Opaque B92</i>	170	→	L ≤ 400	300
	170	↑	L ≤ 180	300
Soltis W88 - Soltis W96 <i>Soltis W88 - Soltis W96</i>	267	→	L ≤ 400	300
	267	↑	L ≤ 277	300
Veozip <i>Veozip</i>	290	→	L ≤ 400	300
	290	↑	L ≤ 300	300

Maßangaben

Détails des dimensions

PE 10, MAXIMALE HERSTELLBARE HÖHE PE 10, HAUTEUR MAXIMALE RÉALISABLE

Gewebe Tissus	H Stoffballen (cm) H nappe (cm)	Anfertigung des Gewebes Réalisation tissu	L Markise (cm) L store (cm)	H Markise (cm) H store (cm)
Acrylics, Polyester <i>Acrylics, Polyester</i>	120	↑	L ≤ 705	300
Lunar Screen 989 <i>Lunar Screen 989</i>	210	→	L ≤ 705	300
PVC 302 - PVC502 <i>PVC 302 - PVC502</i>	180	→	L ≤ 705	300
PVC 622 <i>PVC 622</i>	267	→	L ≤ 705	300
Opatex <i>Opatex</i>	300	→	L ≤ 705	300
Screen SG989 <i>Screen SG989</i>	270	→	L ≤ 705	300
	320	→	L ≤ 705	300
Soltis 86H, Soltis 92P <i>Soltis 86H, Soltis 92P</i>	177	→	L ≤ 705	300
	267	→	L ≤ 705	300
Soltis Opaque B92 <i>Soltis Opaque B92</i>	170	→	L ≤ 705	300
Soltis W88 - Soltis W96 <i>Soltis W88 - Soltis W96</i>	267	→	L ≤ 705	300
Veozip <i>Veozip</i>	290	→	L ≤ 705	300

PE 10 BOX, MAXIMALE HERSTELLBARE HÖHE PE 10 BOX, HAUTEUR MAXIMALE RÉALISABLE

Gewebe Tissus	H Stoffballen (cm) H nappe (cm)	Anfertigung des Gewebes Réalisation tissu	L Markise (cm) L store (cm)	H Markise (cm) H store (cm)
Acrylics, Polyester <i>Acrylics, Polyester</i>	120	↑	L ≤ 470	300
Lunar Screen 989 <i>Lunar Screen 989</i>	210	→	L ≤ 470	300
PVC 302 - PVC502 <i>PVC 302 - PVC502</i>	180	→	L ≤ 470	300
PVC 622 <i>PVC 622</i>	267	→	L ≤ 470	300
Opatex <i>Opatex</i>	300	→	L ≤ 470	300
Screen SG989 <i>Screen SG989</i>	270	→	L ≤ 470	300
	320	→	L ≤ 470	300
Soltis 86H, Soltis 92P <i>Soltis 86H, Soltis 92P</i>	177	→	L ≤ 470	300
	267	→	L ≤ 470	300
Soltis Opaque B92 <i>Soltis Opaque B92</i>	170	→	L ≤ 470	300
Soltis W88 - Soltis W96 <i>Soltis W88 - Soltis W96</i>	267	→	L ≤ 470	300
Veozip <i>Veozip</i>	290	→	L ≤ 470	300

Maßangaben

Détails des dimensions

PE 70, MAXIMALE HERSTELLBARE HÖHE

PE 70, HAUTEUR MAXIMALE RÉALISABLE

Gewebe Tissus	H Stoffballen (cm) H nappe (cm)	Anfertigung des Gewebes Réalisation tissu	L Markise (cm) L store (cm)	H Markise (cm) H store (cm)
Acrylics, Polyester <i>Acrylics, Polyester</i>	120	↑	L ≤ 470	250
Lunar Screen 989 <i>Lunar Screen 989</i>	210	→	L ≤ 470	250
PVC 302 - PVC502 <i>PVC 302 - PVC502</i>	180	→	L ≤ 470	250
PVC 622 <i>PVC 622</i>	267	→	L ≤ 470	250
Opatex <i>Opatex</i>	300	→	L ≤ 470	250
Screen SG989 <i>Screen SG989</i>	270	→	L ≤ 470	250
	320	→	L ≤ 470	250
Soltis 86H, Soltis 92P <i>Soltis 86H, Soltis 92P</i>	177	→	L ≤ 470	250
	267	→	L ≤ 470	250
Soltis Opaque B92 <i>Soltis Opaque B92</i>	170	→	L ≤ 470	250
Soltis W88 - Soltis W96 <i>Soltis W88 - Soltis W96</i>	267	→	L ≤ 470	250
Veozip <i>Veozip</i>	290	→	L ≤ 470	250

PE 70 BOX, MAXIMALE HERSTELLBARE HÖHE

PE 70 BOX, HAUTEUR MAXIMALE RÉALISABLE

Gewebe Tissus	H Stoffballen (cm) H nappe (cm)	Anfertigung des Gewebes Réalisation tissu	L Markise (cm) L store (cm)	H Markise (cm) H store (cm)
Acrylics, Polyester <i>Acrylics, Polyester</i>	120	↑	L ≤ 470	250
Lunar Screen 989 <i>Lunar Screen 989</i>	210	→	L ≤ 470	250
PVC 302 - PVC502 <i>PVC 302 - PVC502</i>	180	→	L ≤ 470	250
PVC 622 <i>PVC 622</i>	267	→	L ≤ 470	250
Opatex <i>Opatex</i>	300	→	L ≤ 470	250
Screen SG989 <i>Screen SG989</i>	270	→	L ≤ 470	250
	320	→	L ≤ 470	250
Soltis 86H, Soltis 92P <i>Soltis 86H, Soltis 92P</i>	177	→	L ≤ 470	250
	267	→	L ≤ 470	250
Soltis Opaque B92 <i>Soltis Opaque B92</i>	170	→	L ≤ 470	250
Soltis W88 - Soltis W96 <i>Soltis W88 - Soltis W96</i>	267	→	L ≤ 470	250
Veozip <i>Veozip</i>	290	→	L ≤ 470	250

Maßangaben

Détails des dimensions

PE 75, MAXIMALE HERSTELLBARE HÖHE PE 75, HAUTEUR MAXIMALE RÉALISABLE

Gewebe Tissus	H Stoffballen (cm) H nappe (cm)	Anfertigung des Gewebes Réalisation tissu	L Markise (cm) L store (cm)	H Markise (cm) H store (cm)
Acrylics, Polyester <i>Acrylics, Polyester</i>	120	↑	L ≤ 470	250
Lunar Screen 989 <i>Lunar Screen 989</i>	210	→	L ≤ 470	250
PVC 302 - PVC502 <i>PVC 302 - PVC502</i>	180	→	L ≤ 470	250
PVC 622 <i>PVC 622</i>	267	→	L ≤ 470	250
Opatex <i>Opatex</i>	300	→	L ≤ 470	250
Screen SG989 <i>Screen SG989</i>	270	→	L ≤ 470	250
	320	→	L ≤ 470	250
Soltis 86H, Soltis 92P <i>Soltis 86H, Soltis 92P</i>	177	→	L ≤ 470	250
	267	→	L ≤ 470	250
Soltis Opaque B92 <i>Soltis Opaque B92</i>	170	→	L ≤ 470	250
Soltis W88 - Soltis W96 <i>Soltis W88 - Soltis W96</i>	267	→	L ≤ 470	250
Veozip <i>Veozip</i>	290	→	L ≤ 470	250

PE 75 BOX, MAXIMALE HERSTELLBARE HÖHE PE 75 BOX, HAUTEUR MAXIMALE RÉALISABLE

Gewebe Tissus	H Stoffballen (cm) H nappe (cm)	Anfertigung des Gewebes Réalisation tissu	L Markise (cm) L store (cm)	H Markise (cm) H store (cm)
Acrylics, Polyester <i>Acrylics, Polyester</i>	120	↑	L ≤ 470	250
Lunar Screen 989 <i>Lunar Screen 989</i>	210	→	L ≤ 470	250
PVC 302 - PVC502 <i>PVC 302 - PVC502</i>	180	→	L ≤ 470	250
PVC 622 <i>PVC 622</i>	267	→	L ≤ 470	250
Opatex <i>Opatex</i>	300	→	L ≤ 470	250
Screen SG989 <i>Screen SG989</i>	270	→	L ≤ 470	250
	320	→	L ≤ 470	250
Soltis 86H, Soltis 92P <i>Soltis 86H, Soltis 92P</i>	177	→	L ≤ 470	250
	267	→	L ≤ 470	250
Soltis Opaque B92 <i>Soltis Opaque B92</i>	170	→	L ≤ 470	250
Soltis W88 - Soltis W96 <i>Soltis W88 - Soltis W96</i>	267	→	L ≤ 470	250
Veozip <i>Veozip</i>	290	→	L ≤ 470	250

Maßangaben

Détails des dimensions

PE 80, MAXIMALE HERSTELLBARE HÖHE

PE 80, HAUTEUR MAXIMALE RÉALISABLE

Gewebe Tissus	H Stoffballen (cm) H nappe (cm)	Anfertigung des Gewebes Réalisation tissu	L Markise (cm) L store (cm)	H Markise (cm) H store (cm)
Acrylics, Polyester <i>Acrylics, Polyester</i>	120	↑	L ≤ 705	150
Lunar Screen 989 <i>Lunar Screen 989</i>	210	→	L ≤ 705	150
PVC 302 - PVC502 <i>PVC 302 - PVC502</i>	180	→	L ≤ 705	150
PVC 622 <i>PVC 622</i>	267	→	L ≤ 705	150
Opatex <i>Opatex</i>	300	→	L ≤ 705	150
Screen SG989 <i>Screen SG989</i>	270	→	L ≤ 705	150
	320	→	L ≤ 705	150
Soltis 86H, Soltis 92P <i>Soltis 86H, Soltis 92P</i>	177	→	L ≤ 705	150
	267	→	L ≤ 705	150
Soltis Opaque B92 <i>Soltis Opaque B92</i>	170	→	L ≤ 705	150
Soltis W88 - Soltis W96 <i>Soltis W88 - Soltis W96</i>	267	→	L ≤ 705	150
Veozip <i>Veozip</i>	290	→	L ≤ 705	150

PE 80 BOX, MAXIMALE HERSTELLBARE HÖHE

PE 80 BOX, HAUTEUR MAXIMALE RÉALISABLE

Gewebe Tissus	H Stoffballen (cm) H nappe (cm)	Anfertigung des Gewebes Réalisation tissu	L Markise (cm) L store (cm)	H Markise (cm) H store (cm)
Acrylics, Polyester <i>Acrylics, Polyester</i>	120	↑	L ≤ 470	150
Lunar Screen 989 <i>Lunar Screen 989</i>	210	→	L ≤ 470	150
PVC 302 - PVC502 <i>PVC 302 - PVC502</i>	180	→	L ≤ 470	150
PVC 622 <i>PVC 622</i>	267	→	L ≤ 470	150
Opatex <i>Opatex</i>	300	→	L ≤ 470	150
Screen SG989 <i>Screen SG989</i>	270	→	L ≤ 470	150
	320	→	L ≤ 470	150
Soltis 86H, Soltis 92P <i>Soltis 86H, Soltis 92P</i>	177	→	L ≤ 470	150
	267	→	L ≤ 470	150
Soltis Opaque B92 <i>Soltis Opaque B92</i>	170	→	L ≤ 470	150
Soltis W88 - Soltis W96 <i>Soltis W88 - Soltis W96</i>	267	→	L ≤ 470	150
Veozip <i>Veozip</i>	290	→	L ≤ 470	150

Kompatibilität

Compatibilité

Produkt Produit		Raso	T-Zone SC98	T-Zone S98	T-Zone S114
Brera P	Am Umfang Périmétrique	●	-	-	-
Opera	Am Umfang Périmétrique	●	-	-	-
Carrera P	Am Umfang Périmétrique	●	-	-	-
Nomo	Am Umfang Périmétrique	●	-	-	-
Sense	Am Umfang Périmétrique	-	●	●	-
Level 63	Vorder Frontale	-	●*	●*	●*
	Seitlich Latérale	-	●	●	●
Level	Vorder Frontale	-	●*	●*	●*
	Seitlich Latérale	-	●	●	●**
Fusion	Vorder Frontale	●	-	-	-
	Seitlich Latérale	-	●	●	●
Meta	Vorder Frontale	●	-	-	-
	Seitlich Latérale	-	●	●	●
Mito	Vorder Frontale	-	●*	●*	●*
	Seitlich Latérale	-	●**	●**	●**
Infinity	Vorder Frontale	-	●*	●*	●*
	Seitlich Latérale	-	●**	●**	●**
Alutecnic	Vorder Frontale	-	-	-	-
	Seitlich Latérale	-	-	-	-

LEGENDE

LÉGENDE

- Kompatibel
Compatible
- Nicht kompatibel
Pas compatible
- * Empfohlene Version mit Tragschienen
La version avec rails porteurs est recommandée
- ** Mit Trägerprofil 12 x 6 cm
Avec courant 12 x 6 cm









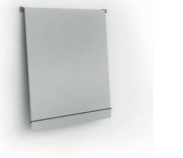

Eigenschaften

Caractéristiques

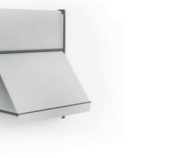
	RASO	T-LOOP S90	T-LOOP S98	T-LOOP S114	T-ZONE SC98	T-ZONE S98	T-ZONE S114	T-BOX CABLES	T-BOX ZIP	T-LINE	T-SQUARE
L min <i>L min</i>	200	80 120 mit LED 120 avec LED	80 120 mit LED 120 avec LED	80 120 mit LED 120 avec LED	61	80	80 120 mit LED 120 avec LED	80	80	80	80
L max <i>L max</i>	600	300	400	500	450	450	500	450	500	400	400
H min <i>H min</i>	150	125	125	125	125	125	125	125	122	100	100
H max <i>H max</i>	300	300	300	350	300	300	350	450	350	450	450
Manuelle Bedienung <i>Actionnement manuel</i>	-	-	-	-	(STD)	(STD)	(STD)	(STD)	(STD)	(STD)	(STD)
Motorantrieb <i>Actionnement à moteur</i>	(STD)	(STD)	(STD)	(STD)	(STD)	(STD)	(STD)	(STD)	(STD)	(STD)	(STD)
Motor mit Solarzelle <i>Moteur avec cellule solaire</i>	-	-	-	-	(GREEN) (STD)	(GREEN) (STD)	(GREEN) (STD)	(GREEN) (STD)	(GREEN) (STD)	-	-
Boxprofil <i>Profilé de coffre</i>	15 × 22	9 × 12,5	9,8 × 15,1	11,4 × 16,7	9,8 × 10,7	9,8 × 13,1	11,4 × 14,5	11 × 17,5	11 × 17,5	Ø 11,9	9,8 × 10,4
Führungsschiene <i>Profilé guide</i>	4,4 × 4	9 × 4	9,8 × 4	11,4 × 4	4,4 × 4; 4,4 × 5÷6	4,4 × 4; 4,4 × 5÷6	4,4 × 4; 4,4 × 5÷6	-	-	-	-
Tuchwelle <i>Tube d'enroulement</i>	7,8; 10,2	6	7	7,8	7	7	7,8	7,8; 8,5	7,8; 8,5	7,8	7
Selbsttragend <i>Autoporteuse</i>	-	(STD)	(STD)	(STD)	(OPT)	(OPT)	(OPT)	-	-	-	-
Wandbefestigung <i>Fixation au mur</i>	-	-	-	-	-	-	-	(STD)	(STD)	(STD)	(STD)
Deckenbefestigung <i>Fixation au plafond</i>	-	-	-	-	(STD)	(STD)	(STD)	(STD)	(STD)	(STD)	(STD)
Hohlraumbefestigung <i>Fixation courette</i>	-	(STD)	(STD)	(STD)	(STD)	(STD)	(STD)	(STD)	(STD)	-	-
LED <i>LED</i>	-	(OPT)	(OPT)	(OPT)	-	-	(OPT)	(OPT)	(OPT)	-	-
Fenster aus Cristal <i>Fenêtres en Cristal</i>	-	-	-	-	(OPT)	(OPT)	(OPT)	(OPT)	(OPT)	-	-
Magnetic Lock System (MLS) <i>Magnetic Lock System (MLS)</i>	-	-	-	-	-	-	-	-	-	(STD)	(STD)
Volant <i>Lambrequin</i>	-	-	-	-	-	-	-	-	-	-	-
Schutzdach <i>Auvent</i>	-	-	-	-	-	-	-	-	-	-	-

Eigenschaften

Caractéristiques

	XX1	X3	PE 10	PE 10 BOX	PE 70	PE 70 BOX	PE 75	PE 75 BOX	PE 80	PE 80 BOX
										
L min <i>L min</i>	80	80	80	80	80	80	80	80	80	80
L max <i>L max</i>	550	470	705	470	470	470	470	470	705	470
H min <i>H min</i>	125	150	200	200	175	175	175	175	100	100
H max <i>H max</i>	350	300	300	300	250	250	250	250	150	150
Manuelle Bedienung <i>Actionnement manuel</i>	(STD)	(STD)	(STD)	(STD)	(STD)	(STD)	(STD)	(STD)	(STD)	(STD)
Motorantrieb <i>Actionnement à moteur</i>	(STD)	(STD)	(STD)	(STD)	(STD)	(STD)	(STD)	(STD)	(STD)	(STD)
Motor mit Solarzelle <i>Moteur avec cellule solaire</i>	-	-	-	-	-	-	-	-	-	-
Boxprofil <i>Profilé de coffre</i>	-	11,5 x 13,8	-	17 x 12,1	-	17 x 12,1	-	17 x 12,1	-	17 x 12,1
Führungsschienprofil <i>Profilé guide</i>	-	-	-	-	-	-	-	-	-	-
Tuchwelle <i>Tube d'enroulement</i>	8,5	7	7,8	7	7	7	7	7	7	7
Selbsttragend <i>Autoporteuse</i>	-	-	-	-	-	-	-	-	-	-
Wandbefestigung <i>Fixation au mur</i>	(STD)	(STD)	(STD)	(STD)	(OPT)	(OPT)	(OPT)	(OPT)	(STD)	(STD)
Deckenbefestigung <i>Fixation au plafond</i>	(STD)	(OPT)	(STD)	(STD)	(STD)	(STD)	(STD)	(STD)	(STD)	(STD)
Hohlraumbefestigung <i>Fixation courette</i>	-	-	-	-	-	-	-	-	-	-
LED <i>LED</i>	-	-	-	-	-	-	-	-	-	-
Fenster aus Cristal <i>Fenêtres en Cristal</i>	(OPT)	(OPT)	(OPT)	(OPT)	(OPT)	(OPT)	(OPT)	(OPT)	-	-
Magnetic Lock System (MLS) <i>Magnetic Lock System (MLS)</i>	(OPT)	(OPT)	-	-	-	-	-	-	-	-
Volant <i>Lambrequin</i>	-	-	(STD)	(STD)	(STD)	(STD)	(STD)	(STD)	(STD)	(STD)
Schutzdach <i>Auvent</i>	(OPT)	-	(OPT)	-	-	-	-	-	(OPT)	-

Technische Vorteile *Avantages techniques*

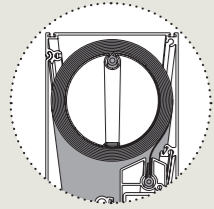

Rollo
Toile à enrouler

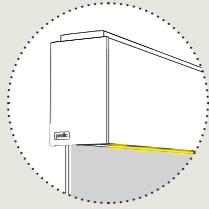

LED
LED

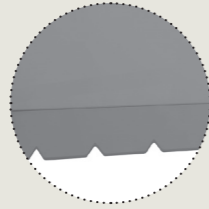

Volant
Lambrequin

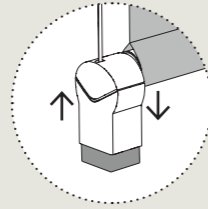

Magnetic Lock System
Magnetic Lock System

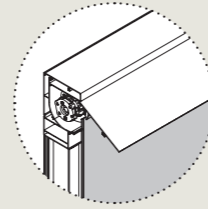

Inspizierbare Box
Coffre avec inspection

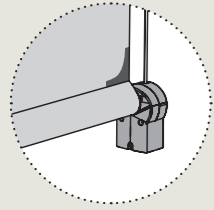

Verstärkte Ecken
Coins renforcés

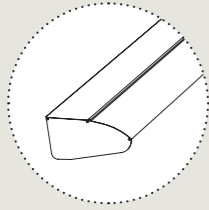

Schutzdach
Auvent

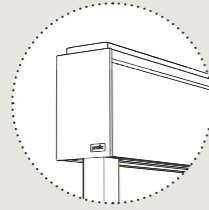

Abstandhalter zur Befestigung
Entretoises pour fixation



Steuerungen und Automatismen
Commandes et automatismes

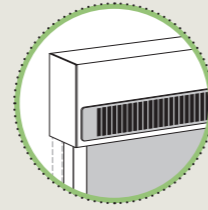

Sonnenkollektor
Cellule solaire
GREEN

PE 70 Box

PRODUKT
PRODUIT

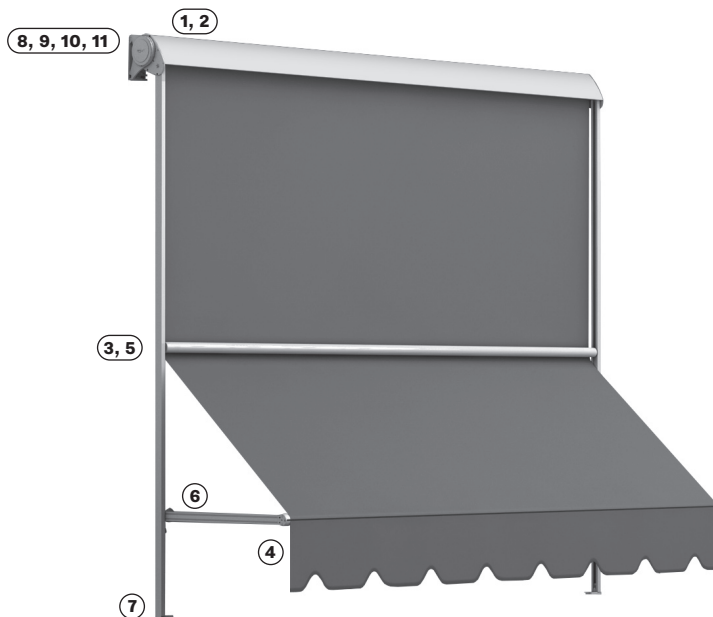

PLUS
PLUS

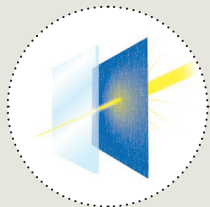

Sonnenschutzdach
Protection solaire

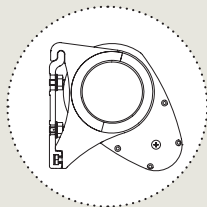

Aluminiumbox
Coffre en aluminium

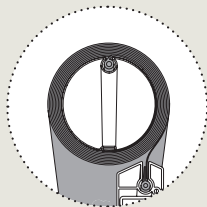

Rollo
Toile à enrouler

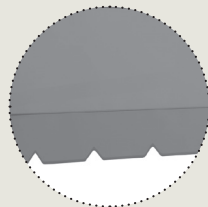

Volant
Lambrequin

FARBEN
COULEURS



GEWEBE
TISSUS



EIGENSCHAFTEN
CARACTÉRISTIQUES



ALU INOX



MADE
IN
ITALY

Technische Eigenschaften

Caractéristiques techniques

- Senkrechte Markise
- Seitliche Führungsschienen und verriegelbaren hervorstehenden Armen in senkrechter Position zur Führungsschiene
- Serienmäßige Vormontage
- Serienmäßiger Volant → **p. A.18**

ABMESSUNGEN

- L max 470 cm
- H max 250 cm
- L und H max je nach gewähltem Gewebe → **p. 5.1.17**

ANTRIEB

- Manuell
- Motor

OPTIONAL

- Befestigungsarten → **p. 5.16.4**
- Schriften, Dekorationen und Logos → **p. A.27**
- Steuerungen und Automatismen → **p. B.1**

- *Store vertical*
- *Rails latéraux et bras saillants qui peuvent être bloqués en position perpendiculaire au rail*
- *Prémontage standard*
- *Profils rails ≥ 250 cm (OPT)*
- *Lambrequin standard* → **p. A.18**

DIMENSIONS

- *L max 470 cm*
- *H max 250 cm*
- *L et H max selon le tissu choisi* → **p. 5.1.17**

ACTIONNEMENT

- *Manuel*
- *Moteur*

OPTIONAL

- *Types de fixation* → **p. 5.16.4**
- *Inscriptions, décorations et logos* → **p. A.27**
- *Commandes et automatismes* → **p. B.1**

Befestigung

Fixation

WANDBEFESTIGUNG

AU MUR

STD

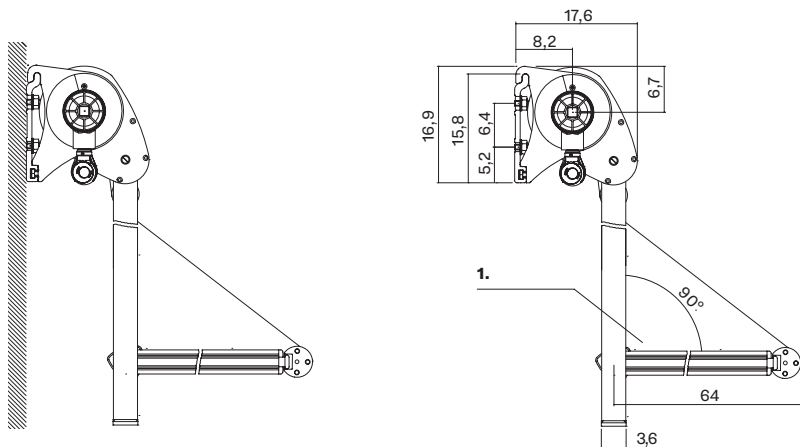

1. Verriegelungsstellung
1. Position de blocage

DECKENBEFESTIGUNG

AU PLAFOND

STD

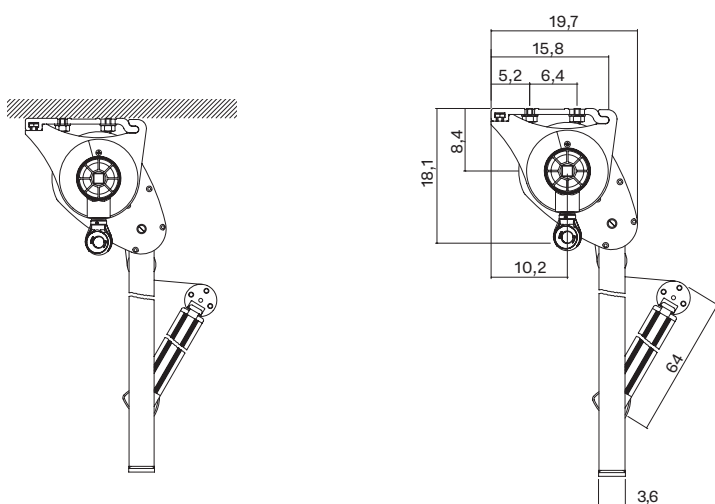

Technische Details

Détails techniques

BOXPROFIL PROFILÉ DE COFFRE

① (STD) (COL)

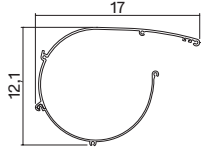

TUCHWELLEPROFIL PROFILÉ TUBE D'ENROULEMENT

② (STD)

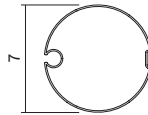

WINDSCHUTZPROFIL PROFILÉ BRISE-VENT

③ (STD) (COL)

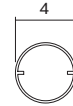

Farbe RAL 9010 Weiß halbgläzend
Couleur RAL 9010 blanc semi-brillant

AUSFALLPROFIL BARRE DE CHARGE

④ (STD) (COL)

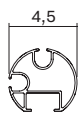

SEITLICHE FÜHRUNGSSCHIENEN RAILS LATÉRAUX

⑤ (STD) (COL)

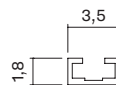

ARM BRAS

⑥ (STD) (COL)

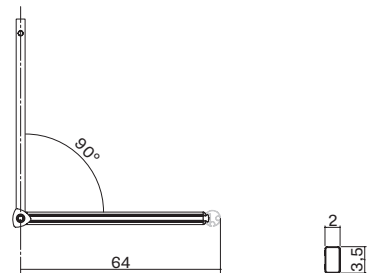

BODEN FÜR FÜHRUNGSSCHIENE BASE POUR RAIL

⑦ (STD) (COL)

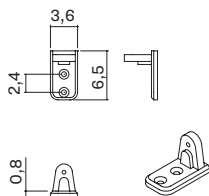

BEFESTIGUNSHALTERUNG BRIDE DE FIXATION

⑧ (STD) (COL)

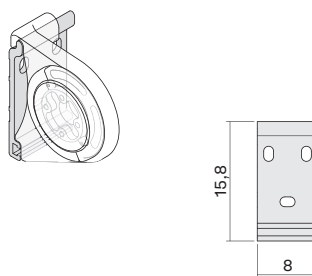

Wandbefestigung
Au mur

BEFESTIGUNSHALTERUNG BRIDE DE FIXATION

⑨ (STD) (COL)

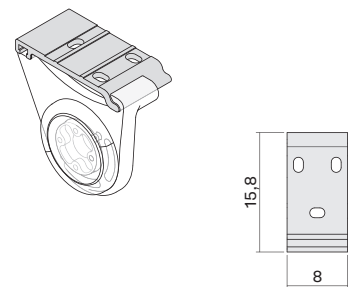

Deckenbefestigung
Au plafond

Technische Details

Détails techniques

ABSTANDSHALTERPROFIL BRIDE ENTRETOISE

10

OPT COL INOX

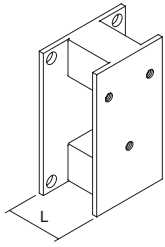

L max 20 cm
L max 20 cm

SEITLICHE HALTERUNG BRIDE LATÉRALE

11

OPT COL

